



BURROW'STM
COMPLETE POST-FRAME SOLUTIONS

STOCK ITEMS

Rev. 09.15.25



EVERYTHING YOU NEED TO SUCCEED

Discover our comprehensive range of high-quality stock items meticulously selected to suit the needs of post-frame contractors.

From essential components to specialized materials, we offer reliable, ready-to-ship solutions that ensure your projects stay on schedule. Partner with us for unmatched support and commitment to your success in every build.

Table of Contents

FRAMING – Pages 2-4

Nail-Lam Columns
.6 CCA Treated Southern Yellow Pine
Untreated Lumber
KDAT, MSR, LVL, SPF, V Bracing, OSB

FOUNDATIONS – Pages 5-7

Brackets
FootingPad
Uplift Plate
Clips
Perma-Column®

TRUSSES – Pages 8-9

Stock Trusses
Special Order Truss Guide

METAL – Pages 10-13

Metal Products Guide
Color Guide
Woodgrain Steel Guide
Trim Solutions

WEATHERPROOFING – Pages 14-15

Foams
Closures
Insulation
House wrap
Pipe Boots
Ridge Vent
Gable Vent

ACCESSORIES – Pages 16-24

Cupolas
Weathervanes
Windows & Skylights
Doors
Sliding Door Hardware

FASTENING & FINISHING – Pages 25-27

Nails
Screws
Washers
Nuts
Touch Up Products

NEW

NAIL-LAM COLUMNS

ALL COLUMNS ARE MECHANICALLY NAILED, GLUED, AND PLANED.

LF FROM 12' TO 40'

BOTTOM-TREATED YELLOW PINE

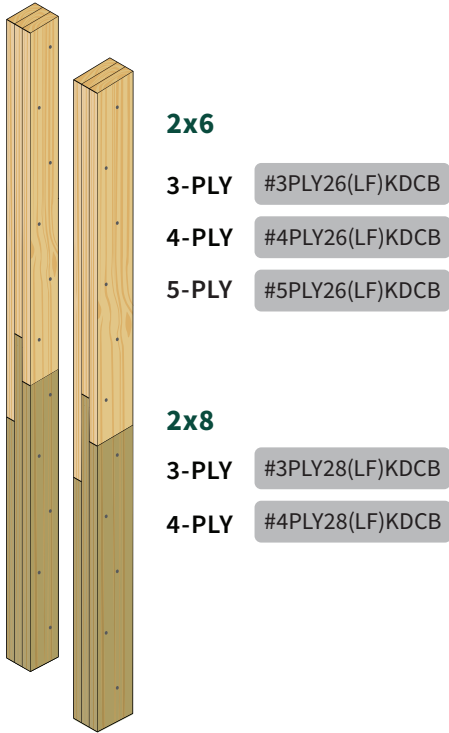

2x6
 3-PLY #3PLY26(LF)KDCB
 4-PLY #4PLY26(LF)KDCB
 5-PLY #5PLY26(LF)KDCB

2x8
 3-PLY #3PLY28(LF)KDCB
 4-PLY #4PLY28(LF)KDCB

FULLY-TREATED YELLOW PINE

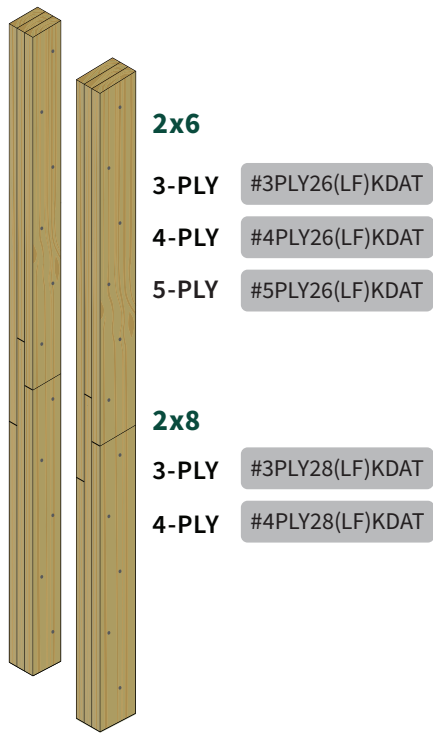

2x6
 3-PLY #3PLY26(LF)KDAT
 4-PLY #4PLY26(LF)KDAT
 5-PLY #5PLY26(LF)KDAT

2x8
 3-PLY #3PLY28(LF)KDAT
 4-PLY #4PLY28(LF)KDAT

NON-TREATED YELLOW PINE

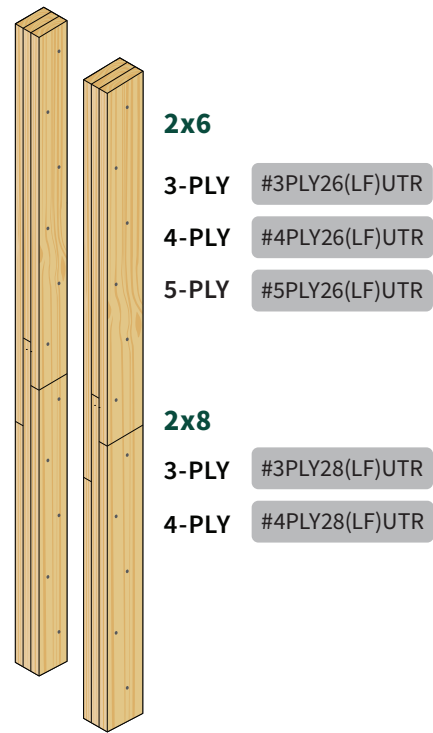

2x6
 3-PLY #3PLY26(LF)UTR
 4-PLY #4PLY26(LF)UTR
 5-PLY #5PLY26(LF)UTR

2x8
 3-PLY #3PLY28(LF)UTR
 4-PLY #4PLY28(LF)UTR

TREATED .6 CCA POSTS

4x4 TREATED YELLOW PINE POSTS

Bundles: 84/ea.
LF: 12'

#4412CCAPOST

5x5 TREATED YELLOW PINE POSTS

Bundles: 45/ea.
LF: 8', 12', 14', 16', 18', 20'

#55(LENGTH)CCAPOST

6x6 TREATED YELLOW PINE POSTS

Bundles: 32/ea.
LF: 14', 16', 18', 20', 22', 24'

#66(LENGTH)CCAPOST

CCA .6 LUMBER

2x4 TREATED YELLOW PINE

Bundles: 208/ea.
Available Grades/LF: #3 - 20'

#24203CCA

2x6 TREATED YELLOW PINE

Bundles: 128/ea.
Available Grades/LF:

- #1 - 12', 14', 16', 18', 20'
- #3 - 10', 12', 16', 20'

#26(LENGTH/GRADE)1KDAT

2x8 TREATED YELLOW PINE

Bundles: 96/ea.
Available Grades/LF: #1 - 12', 16', 20'

#28(LENGTH)1KDAT

UNTREATED LUMBER

2x4 UNTREATED YELLOW PINE

Bundles: 208/ea.

Available Grades/Lengths:

- #2 - 10', 12', 14', 16', 18', 20'
- #3 - 10', 12', 14', 16', 18', 20'

#24(LENGTH/GRADE)YP

2x6 UNTREATED YELLOW PINE

Bundles: 128ea.

Available Grades/Lengths:

- #1 - 12', 14', 16', 18', 20'
- #2 - 12', 16', 18', 20'
- #3 - 10', 12', 14', 16', 18', 20'

#26(LENGTH/GRADE)YP

2x8 UNTREATED YELLOW PINE

Bundles: 96/ea.

Available Grades/Lengths: #3 - 12', 16', 20'

#28(LENGTH/GRADE)YP

2x10 UNTREATED YELLOW PINE

Bundles: 80/ea.

Available Grades/Lengths: #2 - 12', 16', 20'

#210(LENGTH/GRADE)YP

2x12 UNTREATED YELLOW PINE

Bundles: 60/ea.

Available Grades/Lengths: #1 - 12', 16', 20'

#212(LENGTH/GRADE)YP

KDAT LUMBER

2x6 KILN DRIED AFTER TREATMENT (KDAT) LUMBER

Bundles: 128/ea.

Available Lengths: #1 - 12', 14', 16', 18', 20'

#26(LENGTH)1KDAT

MSR LUMBER

2x6 2400 MSR YELLOW PINE

Bundles: 128/ea.

Available Lengths: 14', 16', 20'

#26(LENGTH)MSR

2x8 2400 MSR YELLOW PINE

Bundles: 96/ea.

Available Lengths: 12', 16', 20'

#28(LENGTH)MSR

LVL LUMBER

1 1/2"

Available Sizes:

- 1.5" x 11-7/8" x 20'
- 1.5" x 11-7/8" x 26'
- 1.5" x 16" x 20'
- 1.5" x 18" x 32'

#LVL15(WIDTH)(LENGTH)

SPF LUMBER

2x4 #2 PREMIUM SPF

Bundles: 128/ea.

Available Lengths: 16', 18', 20'

#24(LENGTH)2SPF

#26(LENGTH)2SPF

2x6 #2 PREMIUM SPF

Bundles: 128/ea.

Available Lengths: 12', 16', 18', 20'

V-BRACING

5x5 CCA .6 TREATED YELLOW PINE V-BRACE

Available Lengths: 32" & 48"

#55(LENGTH)VB

6x6 CCA .6 TREATED YELLOW PINE V-BRACE

Available Lengths: 32" & 48"

#66(LENGTH)VB

NAIL LAM V-BRACING

3PLY 2x6 & 2x8- 32" & 48"

4PLY 2x6 & 2x8- 32" & 48"

#(# OF PLYS)PLY(LENGTH)VB

OSB

7/16" ORIENTED STRAND BOARD (OSB) 4'x8' SHEET

Pallets: 128/ea.

#716OSB

7/16" ZIP COMBO RATED SHEATHING - 4'x8' SHEET

Pallets: 128/ea.

#716ZIP

ZIP TAPE - 3.75"x90'

Per roll

#ZIPTAPE

ZIP ROLLER VER.2 - ALUM. w/MARKING MECH.

Qty. 1

#ZIPRLR

FOUNDATIONS



UNIVERSAL STURDI-WALL®
Pallets: 192/ea.
#POSTBUNIV



STURDI-WALL® BRACKET
Pallets: 96/ea.

5x5	6x6	3ply 2x6
#POST B55	#POST B66	#263 PLYBRK



STURDI-WALL® 6C
Pallets: 240/ea.
#POSTBCORN



UPLIFT PLATE
50/Pallet
#UPLFPL



FOOTINGPAD®

10" - 550/ Pallet #FOOTPAD10	16" - 175/ Pallet #FOOTPAD16
------------------------------------	------------------------------------



SCREW ANCHOR
5/8" x 6"
#POSTBANHW10



POST PROTECTORS
Pallets: 192/ea.

5x5 56 Pallet #POST55	6x6 - 42 Pallet #POST66	3ply 2x6 54/Pallet #POST 3PLY26
-----------------------------	-------------------------------	---------------------------------------

SIMPSON STRONG-TIE CONNECTORS



H1A HURRICANE TIE
100/Box
#HURCLIPH1



H2.5A HURRICANE TIE
100/Box
#HURCLIP25



H6 HURRICANE TIE
50/Box
#HURCLIPH6



H10A HURRICANE TIE
50/Box
#HURCLIPH10



LUS JOIST HANGER

2x4 - 100/Box	#JOIST24
2x6 - 100/Box	#JOIST268
2x8 - 50/Box	#JOIST2810
2x10 - 50/ Box	#JOIST21012



PFDB SADDLE HANGER
25/Box
#JOIST268SAD

PRECAST CONCRETE COLUMNS

3PLY 2x6 NAIL LAM

4.675"x 13" Bracket

4-3/16" Pocket

28/Pallet

Hardware Kit (#HW63) Sold Separately

#PC6300

6x6 POST

5.675"x 13" Bracket

5-5/8" pocket

28/Pallet

Hardware Kit (#HW66) Sold Separately

#PC6600

ICC-ES certified Perma-Column® precast concrete columns elevate wood out of the ground, ensuring your building's foundation will never rot.

They combine the economy of post-frame construction with the durability of a concrete foundation. They are constructed of 100% American-made 1/4" steel finished with a tough powder coat, 1/2" and 5/8" grade 60 rebar, and 10,000 psi concrete.



**INCREASE THE
LONGEVITY OF
YOUR BUILD!**

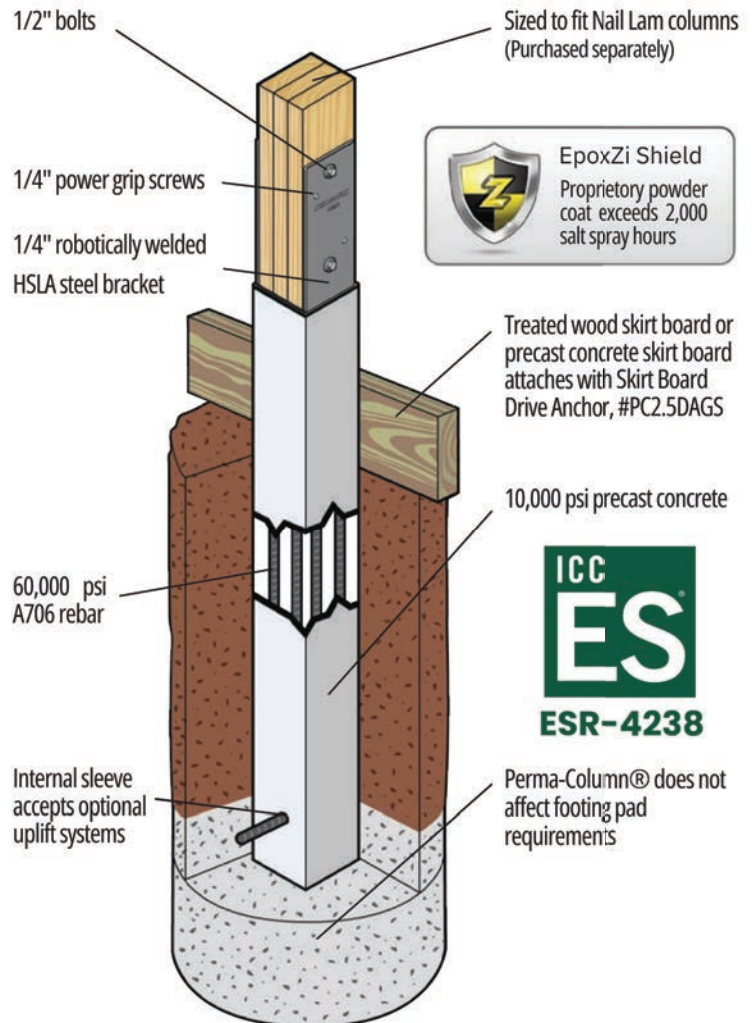

© 2024 Perma-Column, LLC All rights reserved.

PRECAST CONCRETE COLUMN ACCESSORIES



SKIRT BOARD DRIVE ANCHOR

3/16"x2.5" Spiral Concrete Nail
Sold each

2.5DAGS

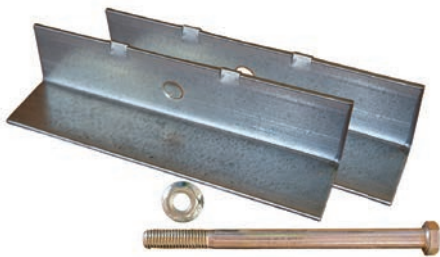

UPLIFT ANCHOR

50/Box

Includes:

- (2) Angles, (1) Bolt/Nut
- (2) 8.5" Uplift Anchor

#UA61

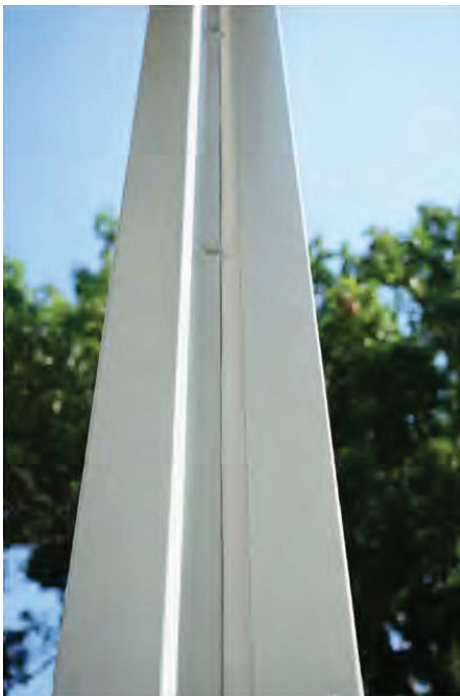
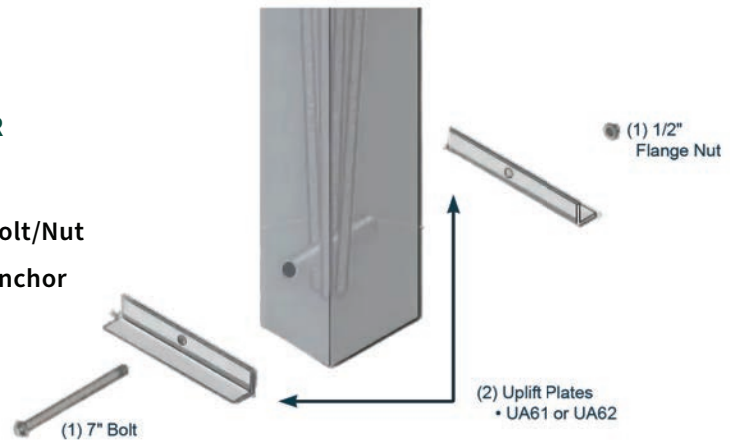

NEW INNOVATIVE TRIM IS DESIGNED TO COVER BOTH THE POST ITSELF, THE PERMA-COLUMN® BASE AND ANY EXPOSED BOLTS!

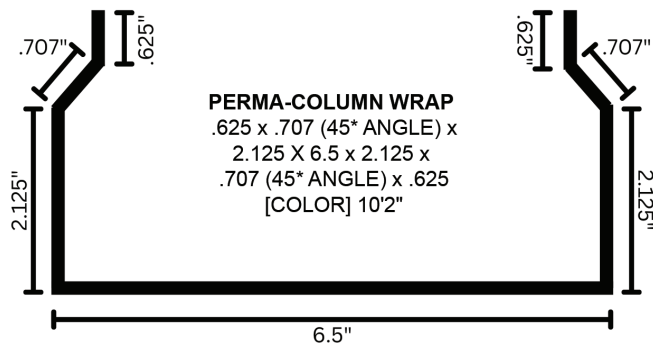

STOCK TRUSSES



30' COMMON/GABLE

2x6 Yellow Pine Chords & Webs

Pitch:

- 4/12

Height:

- 4/12 - 5' 6 1/16"

Use:

- Up to 5' on center. Or Less than or Equal to 5' OC
- 5lbs TC/ 10lbs BC
- 115mph Wind/ 20lbs Snow

#30(PITCH/12)(COMMON/GABLE)



40' COMMON/GABLE

2x6 Yellow Pine Chords & Webs

Pitch:

- 4/12

Height:

- 4/12 - 7' 2 1/16"

Use:

- Up to 5' on center. Or Less than or Equal to 5' OC
- 5lbs TC/ 10lbs BC
- 115mph Wind/ 20lbs Snow

#40(PITCH/12)(COMMON/GABLE)

SPECIAL ORDER TRUSS GUIDE

The Burrow's Truss Department – where precision meets customization. To ensure we craft the perfect truss for your project, we've compiled this list of specifications, guaranteeing accuracy and efficiency in every order.

OVERHANGS

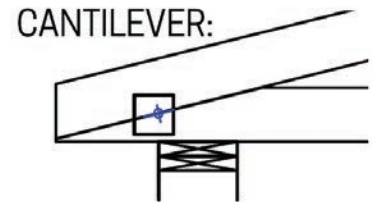
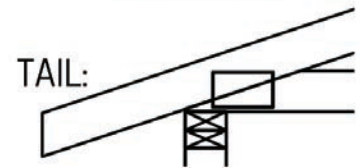

SPECIAL TRUSSES

Length:		Total length from the outside of each bearing wall
Pitch:		2/12 to 12/12 - The higher the first number, the taller the truss.
Bearing Wall:		What dimensions of framing/posts are they using? 5x5, 6x6, 2x4... etc.
OC Spacing:		How far apart will these trusses be spaced? 3'-5' - storage/barn, 2' - buildings w/ sheetrock ceilings.
Overhang:		Fill in with length desired. Note if Tail or Cantilever style.
Snow:		Snow & Wind are lines to note the load ratings needed for this special order design. The ratings will be based on the location of the build. You will need City & State.
Wind:		
Top Chord:		Will the roof be Metal (5lb) or Shingle (10lb)?
Bottom Chord:		Will the ceiling be enclosed? Metal (5lb) or Sheetrock (10lb)?
Common:		Quantity.
Gable:		Quantity.
Scissor:		Quantity or alternative style & quantity.

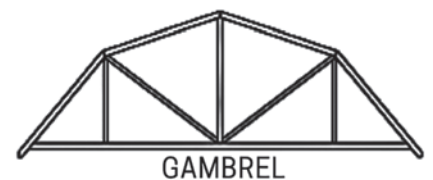
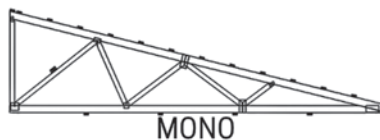

METAL PRODUCTS GUIDE

The Burrow's Metal Department – where quality meets versatility.

To ensure your project's needs are met with precision, we offer customizable options in both 29-gauge and 26-gauge metal, available in a spectrum of colors.

Simply specify your desired quantities, lengths, and dimensions, and let us tailor-make your panels to perfection!

POWERED BY SHERWIN-WILLIAMS® WEATHERXL™ TECHNOLOGY

- All colors available in 29-gauge
- Colors marked with * are also available in 26-gauge
- Colors marked with \$ available in 20 Year Warranty (29-gauge only)

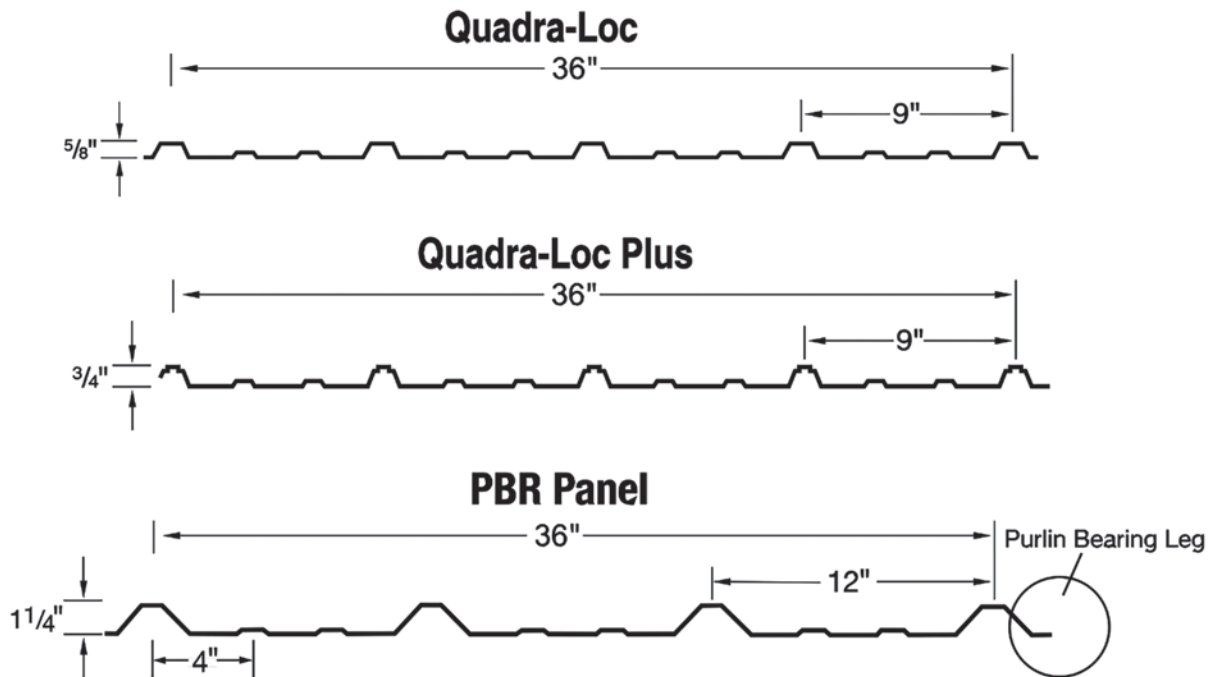

All colors carry a 40-year limited warranty. All Thrifty Colors carry a 20-year limited warranty. See warranty sheets for warranty criteria. Sherwin-Williams® and WeatherXL™ are trademarks of SWIMC LLC.

Paint for all colors is provided by

SHERWIN-WILLIAMS.
Coil Coatings

WeatherXL™

PAINT COLOR GUIDE FOR ROOFING, SIDING, AND TRIM

Choose from our vast selection of paint colors in 29- and 26-gauge steel.



Galvalume® is an internationally recognized trademark of BIEC International, Inc.

TEXTURED COLORS

Textured colors are available in 29-gauge steel only.



NOTE: Actual paint colors may differ from these printed swatches due to the limitations of the printing process. For actual paint colors please request a physical paint chip guide.

40-YEAR PAINT WARRANTY

Sherwin Williams WeatherXL Siliconized Polyester 40-Year Limited Warranty backs our prime line of metal siding, roofing, and trim products against changing color, chalking, cracking, fading, and peeling for 40 years.

WOODGRAIN STEEL GUIDE FOR SIDING AND TRIM



The natural look of wood with the proven performance of steel

Introducing the latest innovation in high-definition digital printing. Choose from three stunningly realistic woodgrain-pattern designs printed on 26-gauge steel.



A product and process like no other

Tru-Steel HD® by Steel Dynamics combines the durability of environmentally friendly electron-beam curing technology with the sustainability of a no-VOC product. Unlimited uses, green for the environment, and timeless beauty.

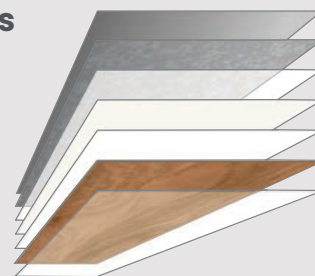

- 1 | Cold-Rolled Steel Base
- 2 | Galvanized/Galvalume® Coating
- 3 | Pretreatment
- 4 | Primer Coat
- 5 | Top Coat
- 6 | High-Definition Image
- 7 | Electron-Beam Protective Clear Coat

20-YEAR CLEAR COAT WARRANTY

Tru-Steel HD® has a 20-Year Limited Warranty on the electron-beam clear-coat barrier protection that helps the steel withstand the elements.

QUADRA-LOC TRIM

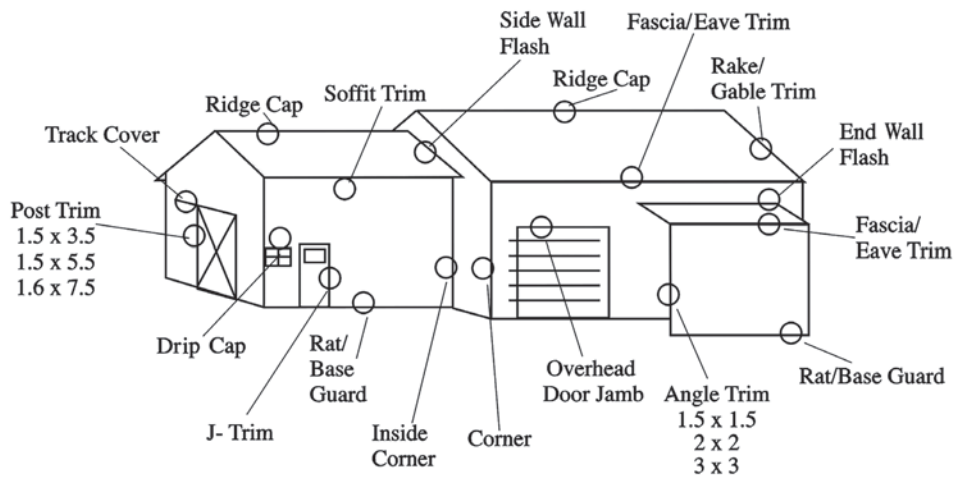
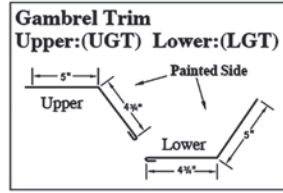
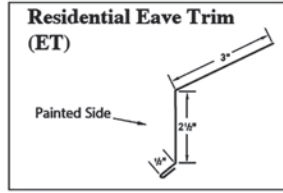
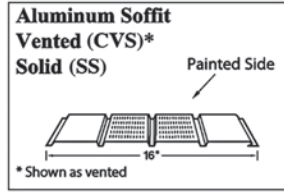
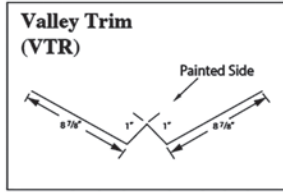
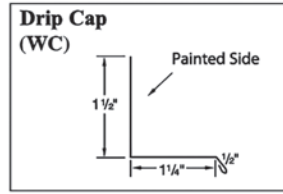
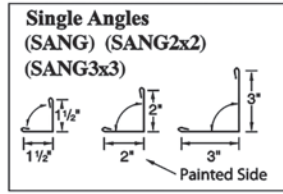
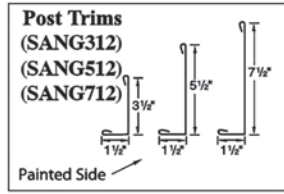
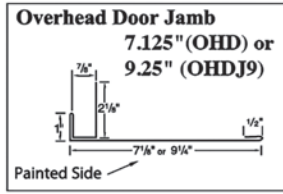
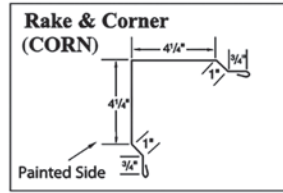
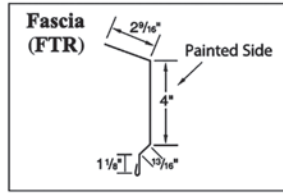
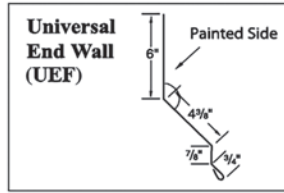
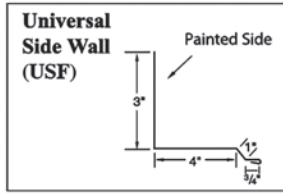
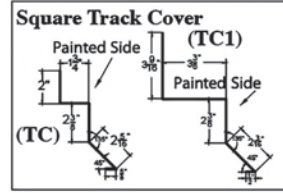
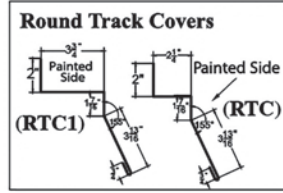
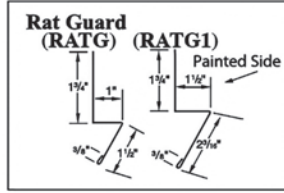
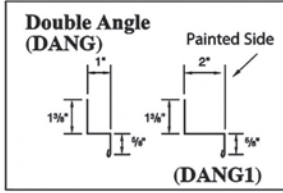
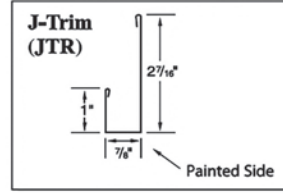
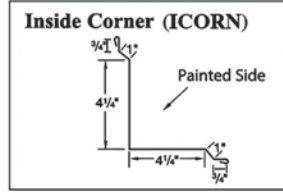
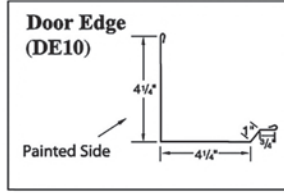
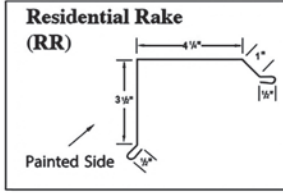
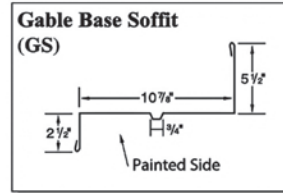
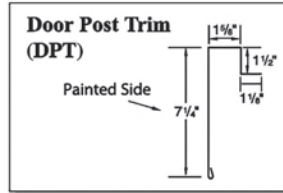
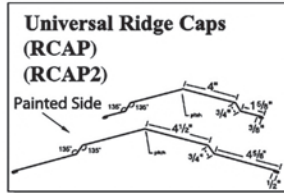
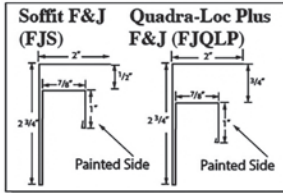

WEATHERPROOFING



POLY FOAM WITH GLUE

Dimensions: 1 1/2" x 1 1/2" x 40'
10/Box

#POLY40GLUE



EM SEAL EXPANDING FOAM

Dimensions: 1/4x 1x 19'
26/Box

#EMSEAL



BUTYL TAPE

Dimensions: 3/8x 45'
40/Box

#BUTYLTAPE

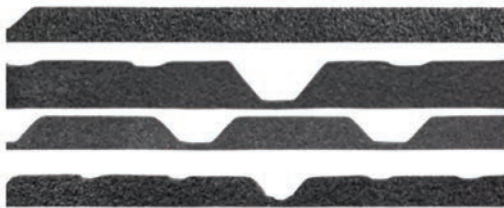

OUTSIDE CLOSURES

3' Wide
Sold in sets of 4 | 100/Box
In Stock Profiles:

- Quadra-Loc
- Quadra-Loc Plus

#CLOSOUT(PROFILE)

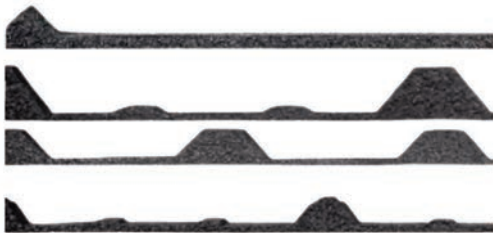

INSIDE CLOSURES

3' Wide
Sold in sets of 4 | 100/Box
In Stock Profiles:

- Quadra-Loc
- Quadra-Loc Plus

#CLOSEINS(PROFILE)



FLEXOVENT

Dimensions: 3" W x 2" T x 20'
1/Box

#FLEXOVENT



VENTED CLOSURE - QLP PROFILE

Dimensions: 3/4" x 3'
25/Box

#VENTCLOSUREQLP

INSULATION & VENTILATION



THERMA-GUARD INSULATION
6' x 125'

NO TAPE: #6125THGRD

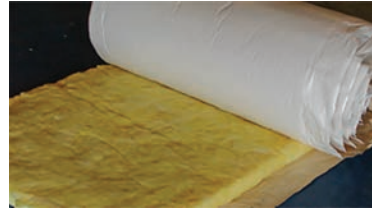

METAL-BUILDING INSULATION
3" R10 Faced Fiberglass
(3' x 100'/roll)

#VBACK3



MF PIPE FLASH

1/4"-4"

#MPF3

3"-6"

#MPF4

5"-9"

#MPF6

7"-13"

#MPF8

9"-20"

#MPF9



HIGH TEMP PIPE FLASH

1/4"-4"

#MPFH3

3"-6"

#MPFH4

5"-9"

#MPFH6

7"-13"

#MPFH8

9"-20"

#MPFH9



RETRO FIT PIPE FLASH

1/2"-4" Zipper

#RETBOOT124



DOUBLE BUBBLE INSULATION

4' x 125'

TAPE

#4125DBTE



GABLE VENT

Color: White | 2/Box

24"x30"

#GABVENT2430WH

30"x30"

#GABVENT3030WH



RIDGE VENT

Stock: All colors

#RDVN(COLOR)

CUPOLAS



STRAIGHT ROOF
36' Model

#CUPRF(COLOR)

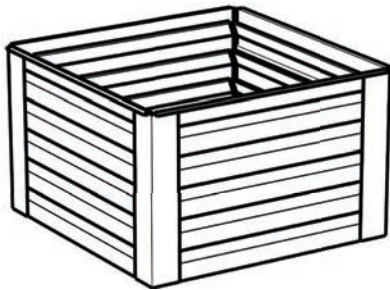

LOUVERED SIDES
36' Model

#CUPSD(COLOR)

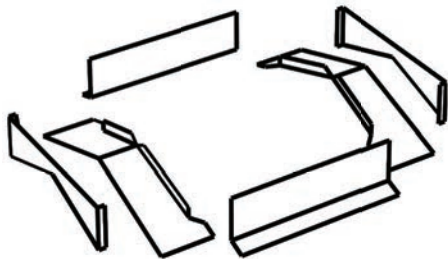

PRE-ASSEMBLED BASE
Must specify pitch (3/12 or 4/12)
36' Model

PN: #CUPBS(COLOR)(312/412)

STANDARD COLORS

BURNISHED SLATE • RURAL RED • MATTE BLACK • ARCTIC WHITE • ALAMO WHITE • CHARCOAL • ASH GRAY

SPECIAL ORDER COLORS

ACRYLIC GALVALUME • EVERGREEN • IVY GREEN • BURGUNDY • BROWN • CRIMSON • LIGHT STONE IVORY
TAN • GALLERY BLUE • TAUPE

STOCK WEATHERVANES

Attaches to cupola roof cap | Height: 29"

24" WEATHERVANES



COW

#WVANECOW24



DOCTOR

#WVANEDOC24



EAGLE

#WVANEEAG24



HORSE

#WVANEHOR24



SPEAR

#WVANESPR24



ROOSTER

#WVANERST24

30" WEATHERVANES



BUCK

#WVANEBK29



EAGLE

#WVANEEAG30



TRACTOR

#WVANETRC29

STRUCTURAL ACCESSORIES: WINDOWS & SKYLIGHTS

- Multi-chambered extruded vinyl frame and sash provide stability with excellent strength, thermal-resistant properties and is extremely low maintenance.
- Integral pre-punched nail fin adds strength, is a weathertight barrier and provides ease of installation.
- Fusion-welded corners in frame and sash provide strength and virtually eliminate air and water infiltration.

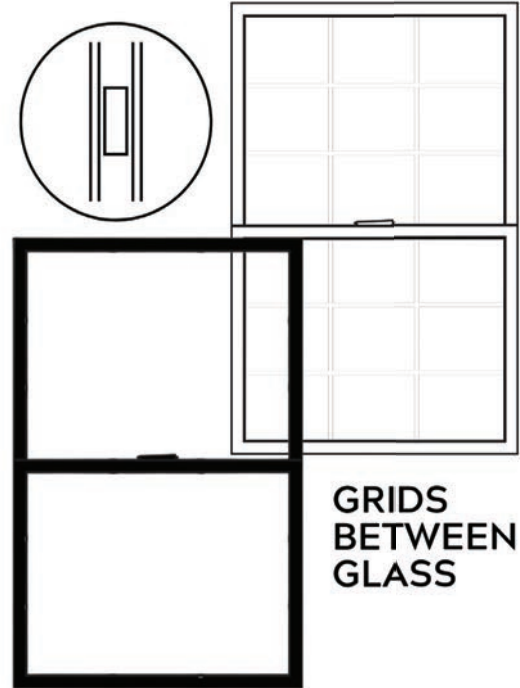

WHITE VINYL WINDOWS

SERIES 400

Single Hung

Double Pane with Grids

Clear Glass

Includes Screen

Sizes on Hand:

- 2' x 3'
- 3' x 3'
- 3' x 4'
- 3' x 5'

#WDWVNL(SIZE)

BLACK VINYL WINDOWS

SERIES 200

Single Hung

Double Pane NO GRIDS

Clear Glass

Includes Screen

LOW-E Argon Filled!

Sizes on Hand:

- 3' x 3'
- 3' x 4'
- 3' x 5'

#WDWVNLBK(SIZE)NG

SKYLIGHT PANELS

QLOC - 12'

White LT 85%

#SKYWHQL12

QLP - 12'

White LT 85%

#SKYWHQLP12

Clear LT 90%

#SKYCLQLP12

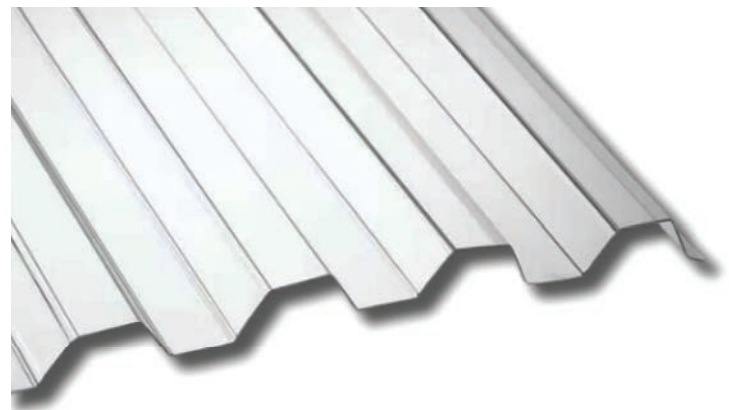

STRUCTURAL ACCESSORIES: DOORS



STANDARD PROFILE – 3' x 6'8"

SERIES 99

WHITE - UNIVERSAL INSWING

Also stocked in 4' x 6'8"

PN: #993068DOOR

SERIES 95

WHITE - RIGHT HAND INSWING

#953068DOORRHINSWING

SERIES 95

WHITE - UNIVERSAL SWING

#203068DRPOL

SERIES 20

WHITE - UNIVERSAL INSWING

#203068DRPOL

SERIES 20

BLACK – RIGHT HAND INSWING

#203068BKRHIS

SERIES 20

BLACK – LEFT HAND INSWING

#203068BKLHIS



1-LITE WITH CROSSBUCKS – 3' x 6'8"

SERIES 20

BLACK – RIGHT HAND INSWING

Foam-filled Jamb

#2030681LTBKRHIS

SERIES 20

BLACK – LEFT HAND INSWING

Foam-filled Jamb

#2030681LTBKLHIS



9-LITE WITH CROSSBUCKS – 3' x 6'8"

SERIES 20

WHITE – RIGHT HAND INSWING

#2030689LTXBKPOLH

SERIES 20

WHITE – LEFT HAND INSWING

#2030689LTXBKPOLH (Note: same number as above)

SLIDING DOOR HARDWARE



INSIDE DOOR STOP - 190500

#ISDRSTP



STEEL BOX GIRTS

Dimensions: 1-1/2" x 3-1/2"

Stock Sizes: 8', 10', 12', 14', 16', 18', 20'

#BOXGIRT(LENGTH)



AV

Color: White

Stock Sizes: 10', 12', 14', 16'

#AV(LENGTH)AR



HV

Color: White

Stock Sizes: 10', 12', 14', 16'

#HV(LENGTH)AR



BOTTOM RAIL WHITE

1-1/2" Sizes: 10', 12', 14', 16'

#BTRAILWH(LENGTH)



CENTER GUIDE

#CENTGUIDE

SLIDING DOOR HARDWARE (CONTINUED)

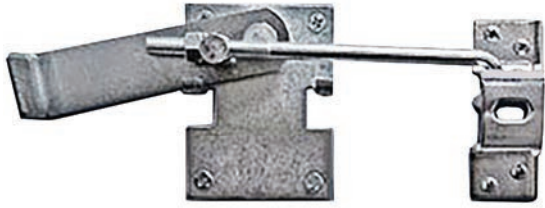

JAMB LATCH 7" HOOK

#JAMBLATCH7



TURNBUCKLE HOOK

#TURNBUCKLE



HASP

#HASP

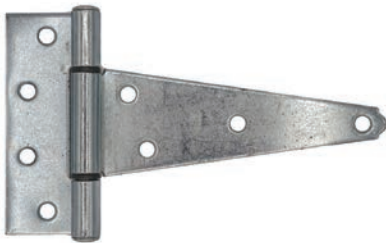

T-HINGE

#THINGE



WHITE HANDLE

#HANDWHT



GALVANIZED HANDLE

#HANDGV

SLIDING DOOR HARDWARE (CONTINUED)



CANNONBALL KEYHOLE® ROUND TRACK

8'

#KHLTR08

10'

#KHLTR10

12'

#KHLTR12



STAY GUIDE™

6'

#STGD06

10'

#STGD10



DELRIN PENDANT BOLT TROLLEYS

#DLRNTRLY



CANNONBALL GUIDE RAIL BRACKET

#CBGUIDEBR



CENTER LATCH

#CENTLATCH

SLIDING DOOR HARDWARE (CONTINUED)



TOP MOUNT BRACKETS

#KHLTMBKT



FACE MOUNT BRACKETS

#KHLFMBKT



FACE MOUNT BIGG FRAME® BRACKET

Special Order



SNUGGERS

#CENTLATCH191500



SPLICE COLLAR

#CBSPLICE



END CAP

#CBRTCAP

SLIDING DOOR HARDWARE

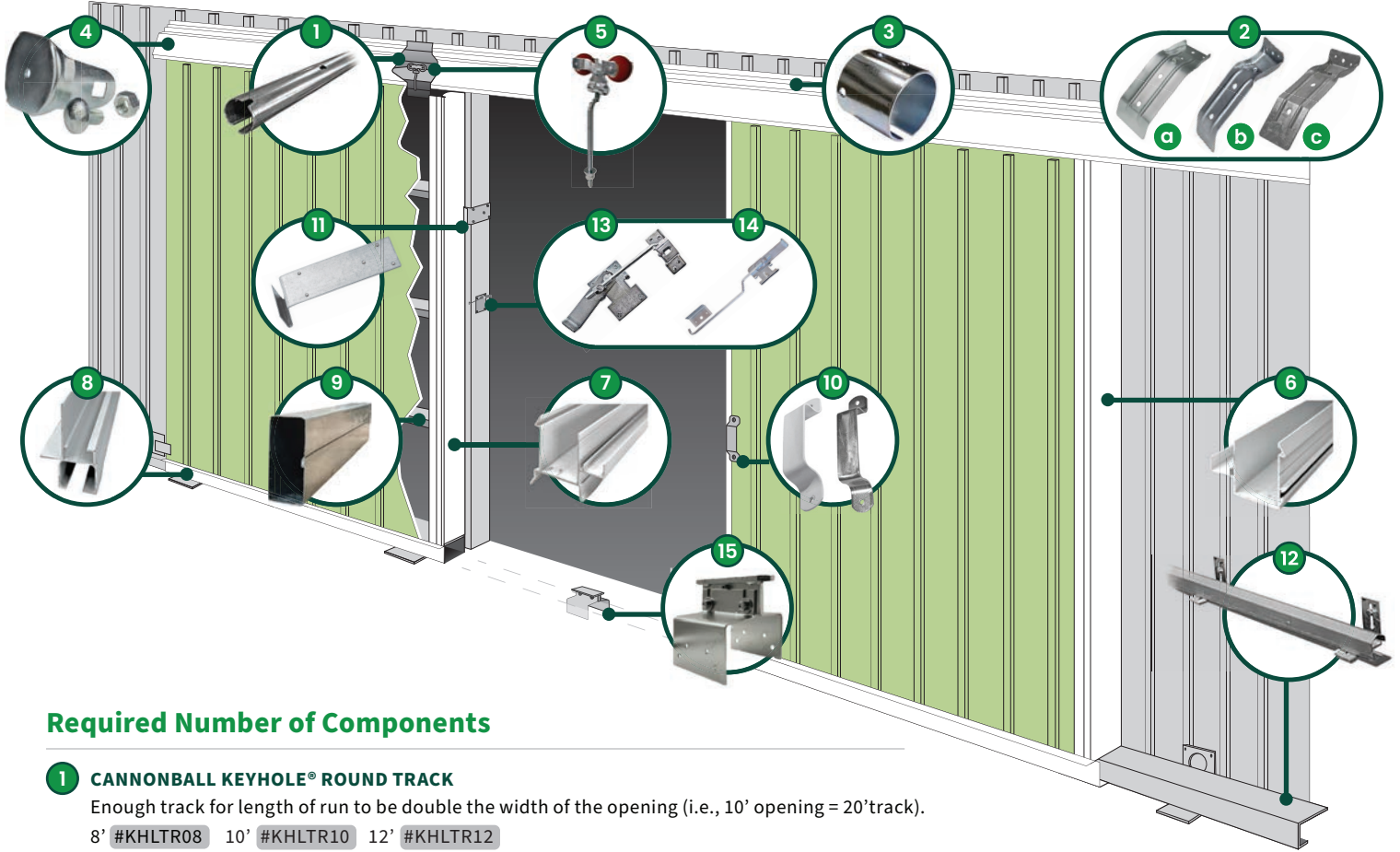

Required Number of Components

- 1 CANNONBALL KEYHOLE® ROUND TRACK**
Enough track for length of run to be double the width of the opening (i.e., 10' opening = 20' track).
8' #KHLTR08 10' #KHLTR10 12' #KHLTR12
- 2 TRACK BRACKETS**
Up to 600# per panel = 1 bracket every 2' of track.
Over 600# = 1 universal bracket every 1' of track.
 - a** Top Mount Brackets #KHLTMBKT
*use track cover #CBTMRTC{CC}{LF}2
 - b** Face Mount Brackets #KHLFMBKT
*use track cover #CBFMRTC{CC}{LF}2
 - c** Face Mount Bigg Frame® Bracket - SPECIAL ORDER
- 3 SPLICE COLLAR** #CBSPLICE One less than number of track sections (i.e., 3 pieces of track requires 2 splice collars).

	Single Panel	Two Panel Split		Single Panel	Two Panel Split
4 END CAP #CBRTCAP	1 PAIR	1 PAIR	10 DOOR PULLS		
5 DELRIN PENDANT BOLT TROLLEYS #DLRNTRLY	1 PAIR	2 PAIR	White Handle #HANDWHT	1	2
6 AV SIDE RAIL (see chart for type) #AV(LENGTH)AR	2	3	Galvanized Handle #HANDGLV		
7 HV DOUBLE COUPLE (see chart for type) #HV(LENGTH)AR	0	1	11 INSIDE DOOR STOP - 190500		
8 BOTTOM RAIL WHITE (see chart for type) #BTRAILWH(LENGTH)	1	2	Often mixed for aesthetic or functional reasons. #ISDRSTP	2	2
9 STEEL BOX GIRTS Provides horizontal support on sliding door frames. Dimensions: 1-1/2" x 3-1/2" Stock Sizes: 8', 10', 12', 14', 16', 18', 20' #BOXGIRT(LENGTH)			12 STAY GUIDE™ Must be 60% of panel width and is recommended. 6' #STGD06 10' #STGD10	1	2
			13 JAMB LATCH 7" HOOK SIDE LATCH Also works as interior door pull. #JAMBLATCH7	2	2
			14 CENTER LATCH Also works as interior door pull. #CENTLATCH	0	1
			15 CENTER GUIDE #CENTGUIDE	0	1

Number of Horizontal Girts Required

Door Panel Height	Door Panel Width (dimensions are for each individual door panel used)											
	6'	7'	8'	9'	10'	12'	14'	16'	18'	20'		
8'	4	4	4	4	4	4	4	6	6	6		
10'	5	5	5	5	5	5	5	7	7	7		
12'	6	6	6	6	6	6	6	8	8	8		
14'	7	7	7	7	7	7	7	9	9	9		
16'	10	10	10	10	10	10	10	10	10	10		
18'	11	11	11	11	11	11	11	11	11	11		
20'	12	12	12	12	12	12	12	12	12	12		

■ = Bigg Frame System Recommended with 3 top horizontal girts & spacers

FASTENING & FINISHING



NOVAFLEX CAULK

12/Box

#NFLEX(COLOR)



PAINT PEN

25/Box

#PAINTPEN(COLOR)



METAL TO WOOD SCREWS

1.5" – 250/Bag, 10/Bags per Box | 2" – 250/Bag, 8/Bags per Box

#(SIZE)MW(COLOR)



16D RING SHANK GALVANIZED NAIL

50lb Box

#NAIL16DRS



16D SMOOTH GALVANIZED NAIL

50lb Box

#NAIL16SM



40D POLE BARN NAIL

25lb Box PN

#NAILPB40MZE25

50lb Box PN

#NAILPB40MZE50

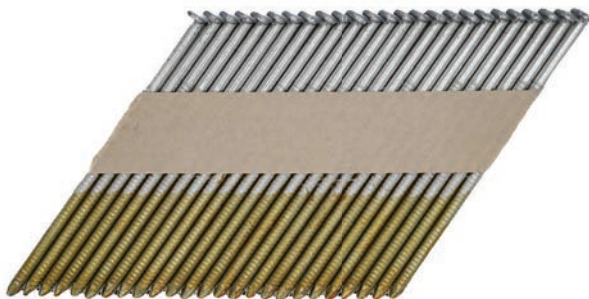

NAIL GUN NAILS

30 degree Paper Taped, Clipped Head, Ring Shank, 3.25"
2,000/Box, 12/Boxes per Pallet

#NAIL30DGALV

FASTENING & FINISHING (CONTINUED)



3" STAR DRIVE DECK SCREW

25lb Box

#DECKSCR3



TIMBER HEX SCREW 5/16" X 4"

#SCREW5164



TIMBER HEX SCREW 5/16" X 6"

1", 1.5", 2"

#TIMBERHEX6



4" GRK RSS™ RUGGED STRUCTURAL SCREWS

100ct

#GRK4

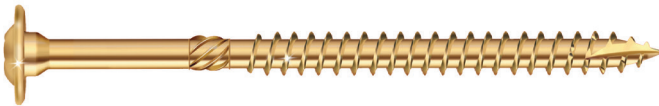

6" GRK RSS™ RUGGED STRUCTURAL SCREWS

50ct

#GRK6



HEX LAG SCREW

3/8" x 2"

#LAGSCREW382

3/8" x 4"

#LAGSCREW384



HEX HEAD GIRDER SCREW

1/4" x 4.5"

#GIRDERSCR



JOIST HANGER SCREWS

#10 x 1 1/2"

#SD10112R500

FASTENING & FINISHING (CONTINUED)



WASHER

1/2" Zinc

#WASHER12

5/8" Galvanized

#WASHER58GV



NUT

1/2" Zinc

#NUT12

5/8" Galvanized

#NUT58GV



SCREW ANCHOR

5/8" x 6"

#POSTBANHW10



WEDGE ANCHOR

5/8" x 5"

#ANC585



CARRIAGE BOLT

1/2" x 6" Zinc Plated

#BOLT126

1/2" x 8" Zinc Plated

#BOLT128

1/2" x 11" Zinc Plated

#BOLT1211

5/8" x 11" Galvanized

#BOLT5811GV

SmartBuild

✓ CUSTOMIZATION: ENDLESS

✓ NO SIGN ON FEE

✓ BENEFITS: LIMITLESS

"With SmartBuild, you can typically increase the deal close rate by 50% and cut bid time to about 20 minutes"

- Build a cut list for sheathing and trim
- Automatically frame their custom structure
- Automatically generate construction drawings
- Design a post frame building in real-time with your clients
- Update the 3D model with a menu-driven set of prompts
- Create material lists and pricing automatically

SmartBuild charges a percentage of each ordered design, which will be added to the total cost of your purchase through Burrow's.



UNLOCK YOUR SALES POTENTIAL WITH FREE BARNDOMINIUM FLOORPLANS

Whether your customers are dreaming of a modern barndo or a classic shop-house, our exclusive, customizable plans—crafted by renowned designer Stacey Lynn—are here to inspire and streamline your build process.

Download now and offer your clients the perfect starting point for their dream homes!



DOWNLOAD
BARNDO FLOOR PLANS



PROUDLY SERVING

Arkansas • Colorado • Illinois • Iowa • Kansas • Kentucky • Louisiana • Mississippi • Missouri
Nebraska • New Mexico • Oklahoma • South Dakota • Tennessee • Texas • Wyoming



BURROW'S
COMPLETE POST-FRAME SOLUTIONS

burrows-supply.com | 800.766.5793

With our commitment to ongoing product improvement, Burrow's reserves the right to change, without notice, product specifications, availability, prices and conditions of sale.

© 2025 Burrow Construction LLC All Rights Reserved. 25-BCI-006